

LAGERTANK MOD. FPS EDELSTAHL AISI 304

COD. O/MANNL.	COD. M/MANNL.	L.	ØF	H1	H2	H3	HSL	HSP	HST	FUESSE	HZA	IMAX	PREIS O/MANNL.	PREIS M/MANNL.
50300	*****	300	620	1275	1000	15	260	65	100	50	60	1345	589,00	*****
50400	50407	400	720	1280	1000	15	265	70	100	50	60	1370	641,00	816,00
50500	50507	500	720	1530	1250	15	265	70	100	50	60	1600	725,00	900,00
50600	50607	600	720	1780	1500	15	265	70	100	50	60	1835	786,00	961,00
50800	50807	800	920	1535	1250	15	270	75	100	50	60	1645	917,00	1.092,00
51000	51007	1000	920	1785	1500	15	270	75	100	50	60	1875	1.163,00	1.338,00
51500	51507	1500	1160	1825	1500	20	305	115	100	60	60	1960	1.799,00	1.974,00
52000	52007	2000	1310	1825	1500	20	305	115	100	60	60	1990	1.999,00	2.174,00

	POS.	SERIENMAESSIGE AUSSTATTUNG			
	1	TUERCHEN MIT HEBEL Ø 400 MM.			
	2	NIROSTA STANDANZEIGER			
	3	RESTABLAUF NIROSTA VENTIL 1"			
WUNSCHAUSSTATTUNG					
	MANNLOCH RUND Ø 300 MM. AUF ANFRAGE		KLEMME UND STANDANZEIGER FUER STICHSSTOFF COD. AC0021 AUF ANFRAGE		
	NIROSTA KOSTHAHN COD. 7090 AUF ANFRAGE		KUGELHAEHNE UND FLACHVENTILE ALLER ART AUF ANFRAGE		
	SCHUTZBLECH FUER STANDROHR COD. 7092 PREIS € 41,00 PRO METER				

IMMEREVOLLTANK MOD. FCG FUER WEIN SYSTEM OENOL. OEL. E. AISI 304





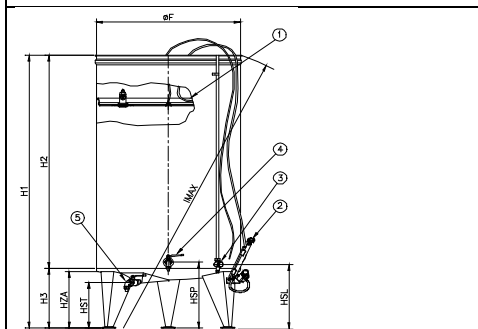

COD. O/MANNL.	COD. M/MANNL.	L.	ØF	H1	H2	H3	HSL	HSP	HST	FUESSE	HZA	IMAX	PREIS O/MANNL.	PREIS M/MANNL.
70300	*****	300	620	1410	1000	410	440	455	315	3	390	1500	617,00	*****
70400	70407	400	720	1410	1000	410	440	455	315	3	390	1525	664,00	839,00
70500	70507	500	720	1660	1250	410	440	455	315	3	390	1755	754,00	929,00
70600	70607	600	720	1910	1500	410	440	455	315	3	390	1995	847,00	1.022,00
70800	70807	800	920	1660	1250	410	440	455	315	3	390	1810	922,00	1.097,00
71000	71007	1000	920	1910	1500	410	440	455	315	3	390	2045	1.109,00	1.284,00
71500	71507	1500	1160	1905	1500	405	435	435	215	3	400	2050	2.069,00	2.244,00
72000	72007	2000	1310	1910	1500	410	440	440	220	3	400	2045	2.535,00	2.710,00

	POS.	SERIENMAESSIGE AUSSTATTUNG			
	1	STAUBDECKEL			
	2	SCHWIMMENDER DECKEL OENOLOGISCHEM OEL SYSTEM			
	3	NIROSTA STANDANZEIGER			
4	KLARABLAUF NIROSTA VENTIL 1"				
5	RESTABLAUF NIROSTA VENTIL 1"				
WUNSCHAUSSTATTUNG					
	MANNLOCH RUND Ø 300 MM. AUF ANFRAGE		H. FUESSE 500 MM. H. FUESSE 600 MM. REGULIERBARE FUESSE AUF ANFRAGE		
	NIROSTA KOSTHAHN COD. 7090 AUF ANFRAGE		KUGELHAEHNE UND FLACHVENTILE ALLER ART AUF ANFRAGE		
	SCHUTZBLECH FUER STANDROHR COD. 7092 PREIS € 41,00 PRO METER				

IMMERVOLLTANK MOD. FCG FUER WEIN LUFTSYSTEM EDELSTHAL AISI 304

COD. O/MANNL.	COD. M/MANNL.	L.	ØF	H1	H2	H3	HSL	HSP	HST	FUESSE	HZA	IMAX	PREIS O/MANNL.	PREIS M/MANNL.
80300	*****	300	620	1410	1000	410	440	455	315	3	390	1500	694,00	****
80400	80407	400	720	1410	1000	410	440	455	315	3	390	1525	786,00	961,00
80500	80507	500	720	1660	1250	410	440	455	315	3	390	1755	861,00	1.036,00
80600	80607	600	720	1910	1500	410	440	455	315	3	390	1995	954,00	1.129,00
80800	80807	800	920	1660	1250	410	440	455	315	3	390	1810	1.046,00	1.221,00
81000	81007	1000	920	1910	1500	410	440	455	315	3	390	2045	1.155,00	1.330,00
81500	81507	1500	1160	2160	1500	405	435	435	215	3	400	2115	2.213,00	2.388,00
82000	82007	2000	1310	2165	1500	410	440	440	220	3	400	2170	2.642,00	2.817,00







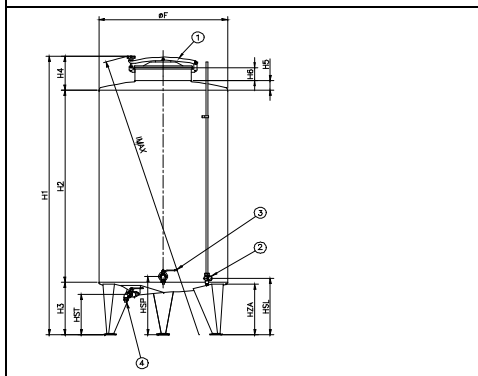

POS.	SERIENMAESSIGE AUSSTATTUNG		
1	SCHWIMMENDER DECKEL LUFTSYSTEM		
2	ZUBEHOER KOMPLETT LUFTSYSTEM		
3	NIROSTA STANDANZEIGER		
4	KLARABLAUF NIROSTA VENTIL 1"		
5	RESTABLAUF NIROSTA VENTIL 1"		
WUNSCHAUSSTATTUNG			
	MANNLOCH RUND Ø 300 MM. AUF ANFRAGE		GALGE CODE 7093 PREIS € 92,00
	NIROSTA KOSTHAHN COD. 7090 AUF ANFRAGE		H. FUESSE 500 MM. H. FUESSE 600 MM. REGULIERBARE FUESSE AUF ANFRAGE
	SCHUTZBLECH FUER STANDROHR COD. 7092 PREIS € 41,00 PRO METER		KUGELHAEHNE UND FLACHVENTILE ALLER ART AUF ANFRAGE

LAGERTANK MOD. FCGS EDELSTAHL AISI 304

COD. O/MANNL.	COD. M/MANNL.	L.	ØF	H1	H2	H3	HSL	HSP	HST	FUESSE	HZA	IMAX	PREIS O/MANNL.	PREIS M/MANNL.
60300	*****	300	620	1670	1000	410	260	455	315	3	390	1670	816,00	****
60400	60407	400	720	1675	1000	410	265	455	315	3	390	1675	878,00	1.053,00
60500	60507	500	720	1925	1250	410	265	455	315	3	390	1925	972,00	1.147,00
60600	60607	600	720	2175	1500	410	265	455	315	3	390	2170	1.038,00	1.213,00
60800	60807	800	920	1930	1250	410	270	455	315	3	390	1990	1.206,00	1.381,00
61000	61007	1000	920	2180	1500	410	270	455	315	3	390	2235	1.394,00	1.569,00
61500	61507	1500	1160	2210	1500	405	305	435	215	3	400	2235	2.271,00	2.446,00
62000	62007	2000	1310	2215	1500	410	305	440	220	3	400	2245	2.585,00	2.760,00



POS.	SERIENMAESSIGE AUSSTATTUNG		
1	TUERCHEN MIT HEBEL Ø 400 MM.		
2	NIROSTA STANDANZEIGER		
3	KLARABLAUF NIROSTA VENTIL 1"		
4	RESTABLAUF NIROSTA VENTIL 1"		
WUNSCHAUSSTATTUNG			
	MANNLOCH RUND Ø 300 MM. AUF ANFRAGE		KLEMME UND STANDANZEIGER FUER STICHSOFF COD. AC0021 AUF ANFRAGE
	NIROSTA KOSTHAHN COD. 7090 AUF ANFRAGE		H. FUESSE 500 MM. H. FUESSE 600 MM. REGULIERBARE FUESSE AUF ANFRAGE
	SCHUTZBLECH FUER STANDROHR COD. 7092 PREIS € 41,00 PRO METER		KUGELHAEHNE UND FLACHVENTILE ALLER ART AUF ANFRAGE

LAGERTANK MOD. DANUBIO EDELSTAHL AISI 304													
CODE	L.	ØF	H1	H2	H3	H4	HSL	HSP	HST	HZA	HP	IMAX	PREIS €
60801	800	920	1835	1250	410	175	510	540	315	390	170	1840	1.286,00
61001	1000	920	2085	1500	410	175	510	540	315	390	170	2090	1.392,00
61501	1500	1160	2085	1500	405	175	510	540	315	400	170	2100	2.466,00
62001	2000	1310	2085	1500	405	175	510	540	315	400	170	2110	2.903,00
62501	2500	1310	2565	1875	515	175	510	540	415	510	170	2635	3.362,00
63001	3000	1310	2940	2250	515	175	510	540	415	510	170	3010	3.721,00

	POS.	SERIENMAESSIGE AUSSTATTUNG		
	1	MANNLOCH OVAL 300X435		
	2	EINFUELLSTUTZE IG DIN 11851/405 DN50		
	3	NIROSTA STANDANZEIGER		
	4	KLARABLAUF NIROSTA VENTIL 1"		
	5	RESTABLAUF NIROSTA VENTIL 1"		
WUNSCHAUSSTATTUNG				
	NIROSTA KOSTHAHN COD.7090 AUF ANFRAGE			
	SCHUTZBLECH FUER STANDROHR COD.7092 PREIS € 41,00 PRO METER			
	KUGELHAEHNE UND FLACHVENTILE ALLER ART AUF ANFRAGE			